

E **Track Systems**

1.40 3-WAY

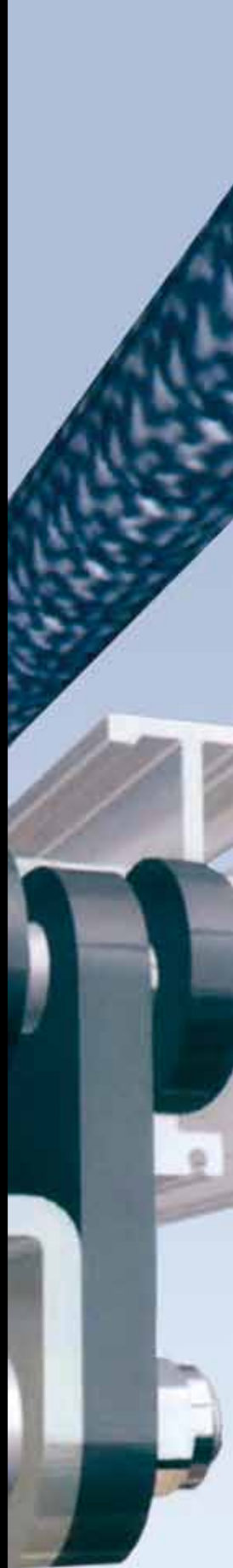

1.40 3-WAY

The Compact Track System for Stage and Exhibition Use

3-WAY: An internal rope drawn track for light- and medium duty applications.

Curtain Track Options

- Walk-along track.
- Internal rope drawn track.

Stacking Space Calculation

For each side of curtain, multiply:
 number of runners
 x length of each runner (approx. 3 – 5 runners per meter)
 + length of master runner
 + lengths of head and return pulleys.
 + length of end stop.

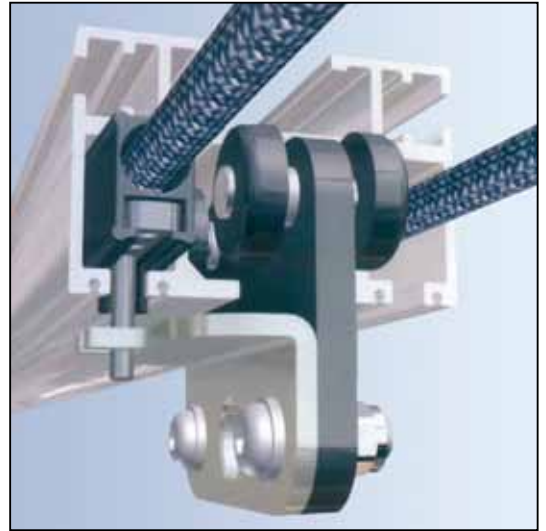

3-WAY

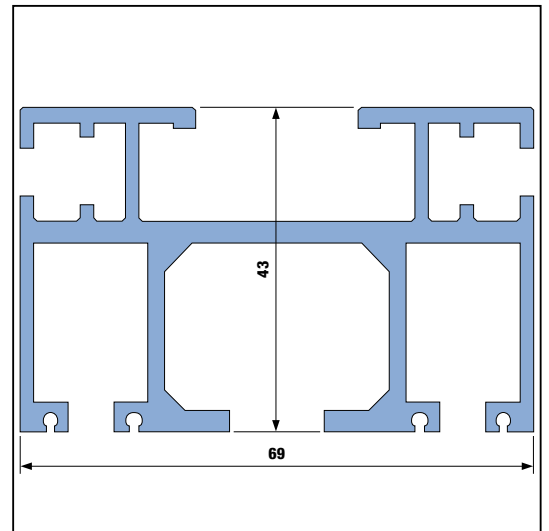

Track Section Scale 1:1

1.40 3-WAY

Walk-Along Track

Walk-along track systems without motor operation. Manually opening and closing.

The basic system to open and close curtains or to move scenery along a track.

Mounting Considerations

Please calculate height measurements for system design and installation.

Length of runner must be included in stacking area calculation.

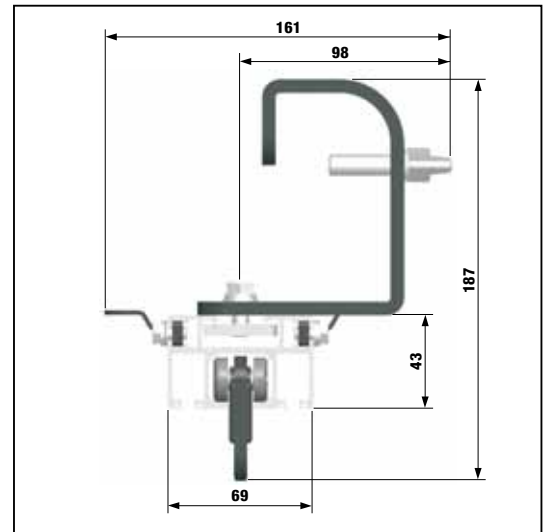

End View

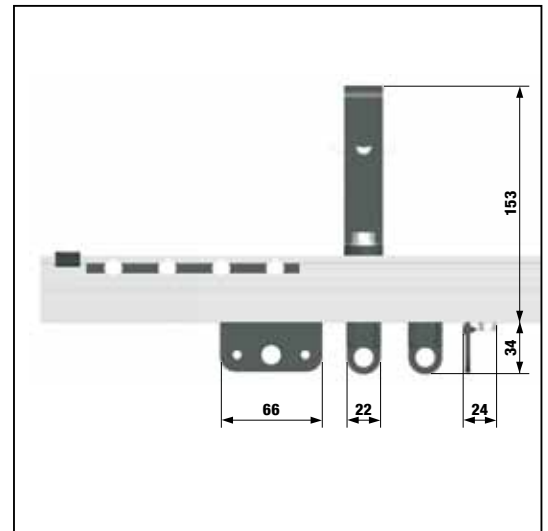

End View

List of Parts for Sample System Below

Art.-No.	Article	Seite
3140 1012	Track, straight, clear anodized	193
3140 1032	Track, curved - with splice, clear anodized	193
3140 9111	Track splice set	193
3140 8021	Hook clamp, direct, black	194
3140 1051	End stop, black	194
3140 0011	4-Wheel runner	193
3140 0041	Overlap arm, black	194
3140 0031	2-wheel runner, ball bearing	193

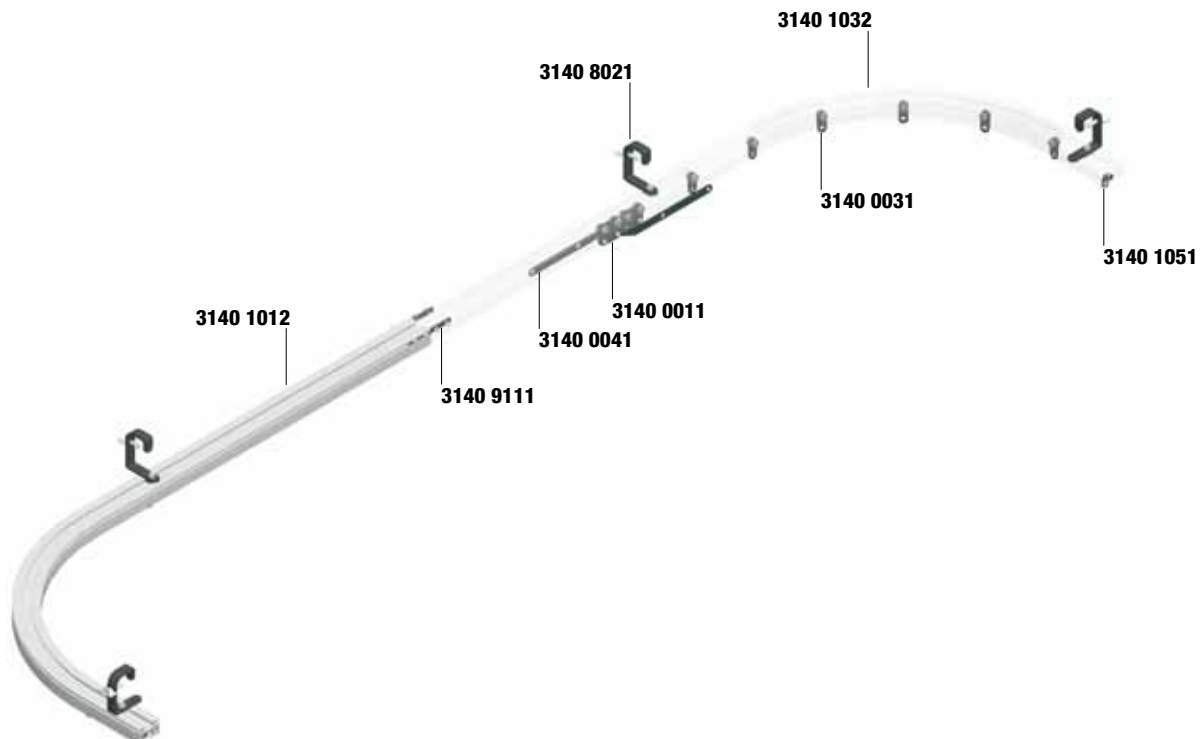

1.40 3-WAY: Walk-Along Track

Art.- No.	Track, Straight	Length cm	Weight g/rm
	<ul style="list-style-type: none"> Extruded Aluminum profile / ALMgSi 0,5 F22. Groove at the side of the track for track splice connection. 		
3140 1011	Colour: black anodized	600	1.830
3140 1012	Colour: clear anodized	600	1.830
3140 1021	Cut length: black anodized	up to 600	1.830
3140 1022	Cut length: clear anodized	up to 600	1.830

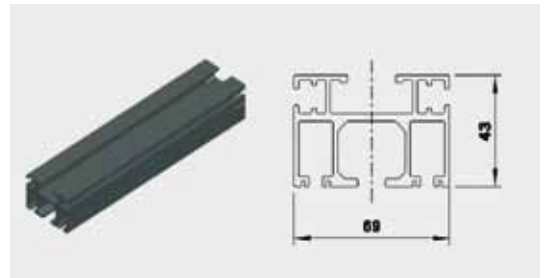

Art.- No.	Track, Curved - with Splice	Weight g/rm
	<ul style="list-style-type: none"> Technical details: see track, straight. Min. radius: R = 100 cm. 	
3140 1031	Colour: black anodized	1.830
3140 1032	Colour: clear anodized	1.830



Art.- No.	Track Splice Set	Weight g
	<ul style="list-style-type: none"> 2 track splices. With joint pins for track connection. 	
3140 9111	Colour: black	175

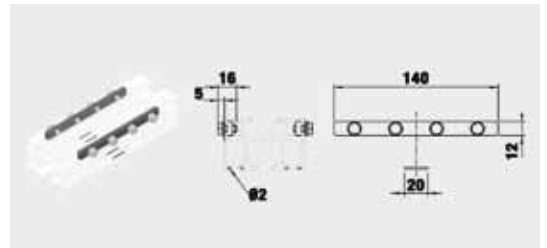

Art.- No.	2-Wheel Runner	Weight g
	<ul style="list-style-type: none"> 2 plastic load bearing wheels. Friction bearing. 	
3140 0021	Colour: black	15

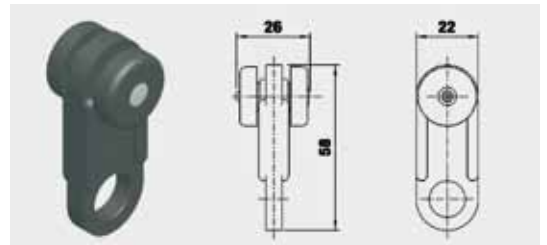

Art.- No.	2-Wheel Runner	Weight g
	<ul style="list-style-type: none"> 2 plastic load bearing wheels. Ball bearing. 	
3140 0031	Colour: black	15

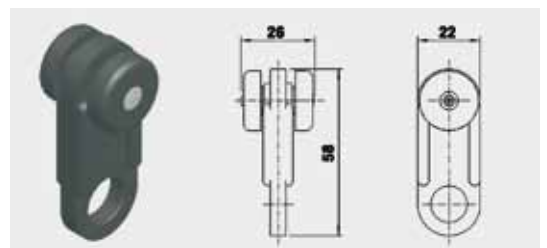

Art.- No.	4-Wheel Runner	Weight g
	<ul style="list-style-type: none"> 4 plastic load bearing wheels. Ball bearing. 	
3140 0011	Colour: black	45

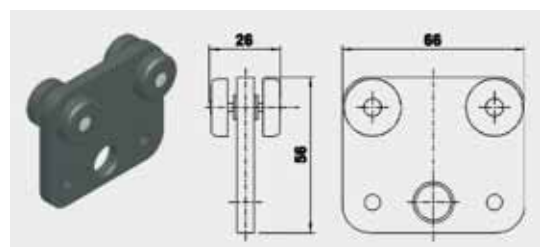

1.40 3-WAY: Walk-Along Track

Art.- No.	Overlap Arm			Weight g
	<ul style="list-style-type: none"> • Mounts to a 4-wheel runner. • With bolts. 			
3140 0041	Colour: black			200
3140 0042	Colour: silver			200

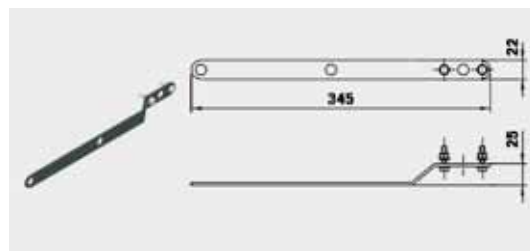

Art.- No.	Extension Arm			Weight g
	<ul style="list-style-type: none"> • Mounts to runner. • Aligns one-piece curtain directly to the wall. • With attachment bolts. 			
3140 0051	Colour: black			80
3140 0052	Colour: silver			80

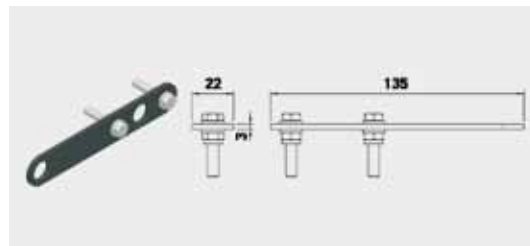

Art.- No.	End Stop			Weight g
	<ul style="list-style-type: none"> • With curtain attachment. 			
3140 1051	Colour: black			30
3140 1052	Colour: silver			30

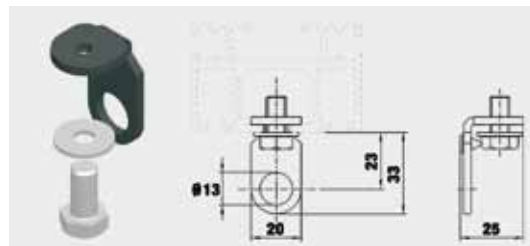

Art.- No.	Hook Clamp			Weight g
	<ul style="list-style-type: none"> • With attachment for direct track mounting. • For pipe diameter: 48 – 60 mm. 			
3140 8021	Colour: black			420
3140 8022	Colour: silver			420

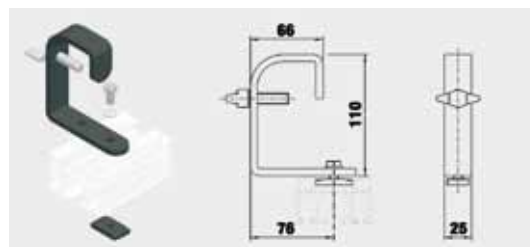

Art.- No.	Ceiling Mounting Bracket, 10 Pieces Set			Weight g/piece
	<ul style="list-style-type: none"> • For ceiling and suspension mounting. 			
3140 8031	Colour: black			70

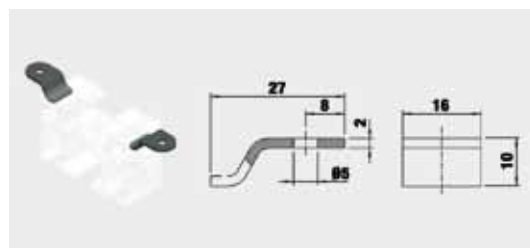

Art.- No.	Wall Mount Bracket 150		Length mm	Weight g
	<ul style="list-style-type: none"> • With attachment for direct track mounting. 			
3140 8061	Colour: black		150	486
3140 8062	Colour: silver		150	486

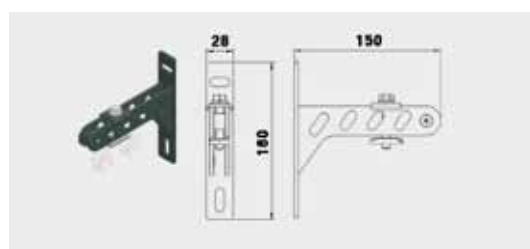

ELEGANCE
+ 3-WAY

1.40 3-WAY: Walk-Along Track

Art.- No.	Wall Mount Bracket 250 • With attachment for direct track mounting.	Length mm	Weight g
3140 8071	Colour: black	250	654
3140 8072	Colour: silver	250	654

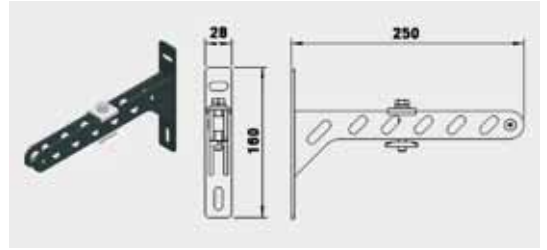

Art.- No.	Attachment Bolt M8 • For direct track mounting. • With 3 nuts, washers and camlock nut.	Weight g
3140 8052	Colour: silver	50

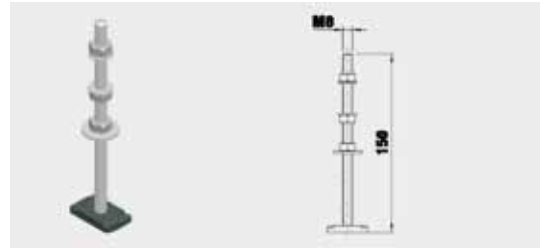

Art.- No.	Camlock Nut • For suspension mounting. • Can be positioned at any place in the top groove of the track. • With thread to accept M8 bolt.	Weight g
3140 8012	Colour: silver	25

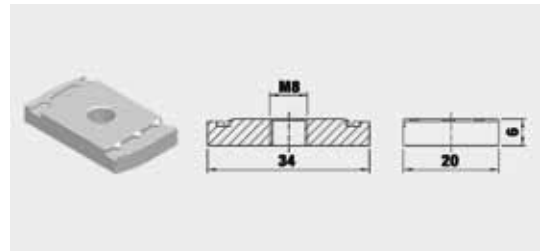

1.40 3-WAY

Internal Rope Drawn Track

Mounting Considerations

3-WAY is an internal rope and runner track system with compact size and minimal space requirements. The system can be directly ceiling mounted via ceiling mounting brackets.

Please calculate height measurements for system design and installation.

Please calculate length of each head and return pulley for stacking space.

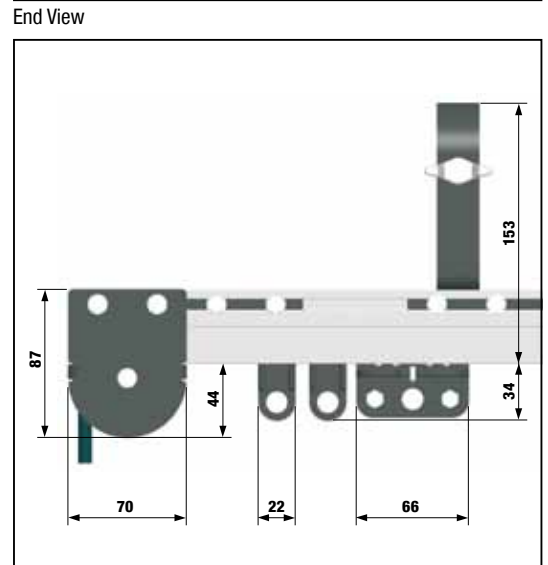
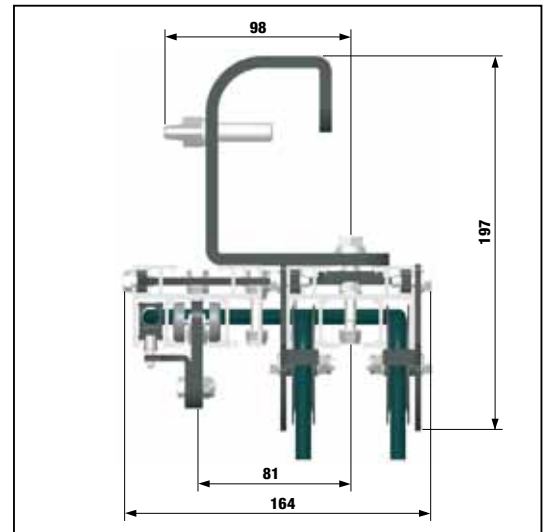

List of Parts for Sample System Below

Art.-No.	Article	Page
3140 1012	Track, straight, clear anodized	197
3140 1042	Overlap track assembly, silver	197
3140 9111	Track connector set	197
3140 8021	Hook clamp, direct, black	199
3140 6021	Head pulley, black	198
3140 6041	Return pulley, black	199
3140 1051	End stop (no shown)	198
3140 6011	Carrier (no shown)	198
3140 0031	2-Wheel runner, ball bearing	197
4101 1182	Polyester rope Ø 8 mm	200
3140 7011	Floor pulley	200

ELEGANCE
+ 3-WAY

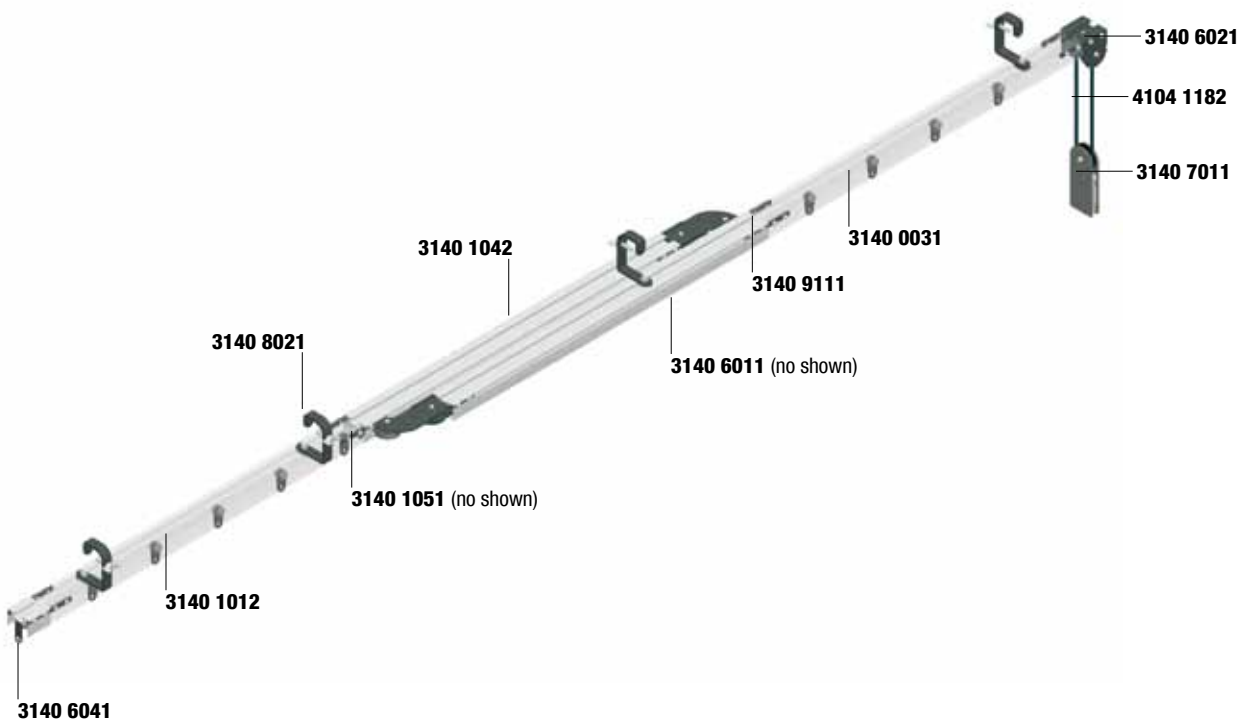

1.40 3-WAY: Rope Drawn Operation

Art.- No.	Track, Straight		Length cm	Weight g/rm
	<ul style="list-style-type: none"> Extruded Aluminum profile, ALMgSi 0,5 F22. Grooves on side of track for track splices. 			
3140 1011	Colour: black anodized		600	1.830
3140 1012	Colour: clear anodized		600	1.830
3140 1021	Cut length: black anodized		up to 600	1.830
3140 1022	Cut length: clear anodized		up to 600	1.830

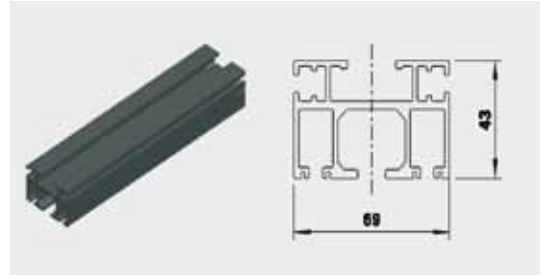

Art.- No.	Track, Curved - with Splice			Weight g/rm
	<ul style="list-style-type: none"> Technical Details see: track, straight. Minimum radius: R = 100 cm. 			
3140 1031	Colour: black anodized			1.830
3140 1032	Colour: clear anodized			1.830



Art.- No.	Track Splice Set			Weight g
	<ul style="list-style-type: none"> 2 track splices. Joint pins for precise track connection. 			
3140 9111	Colour: black			175

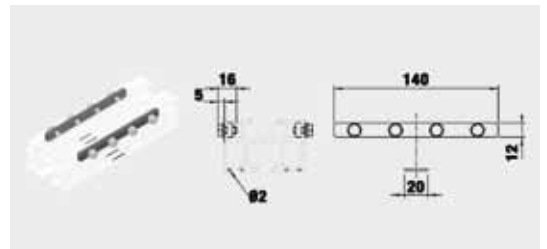

Art.- No.	Overlap Track Assembly		Length mm	Weight g
	<ul style="list-style-type: none"> For center overlap of two separate track sections. With crossover pulleys. 			
3140 1041	Colour: black		1340	5.165
3140 1042	Colour: silver		1340	5.165

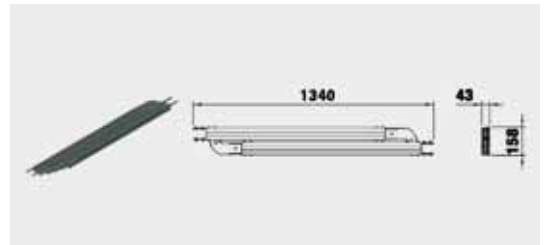

Art.- No.	2-Wheel Runner			Weight g
	<ul style="list-style-type: none"> 2 plastic load bearing wheels. Friction bearing. 			
3140 0021	Colour: black			15

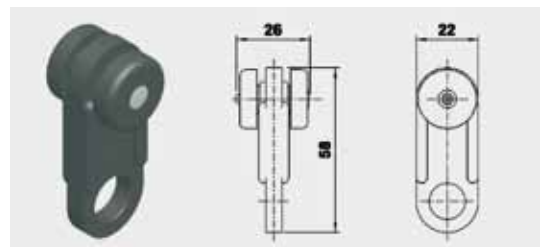

Art.- No.	2-Wheel Runner			Weight g
	<ul style="list-style-type: none"> 2 plastic load bearing wheels. Ball bearing. 			
3140 0031	Colour: black			15

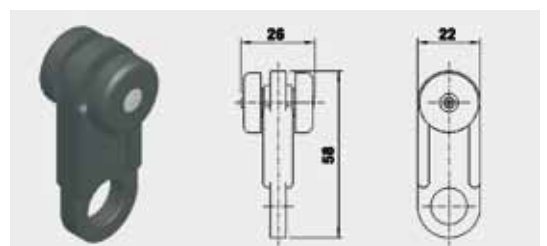

ELEGANCE
+ 3-WAY

1.40 3-WAY: Rope Drawn Operation

Art.- No.	Master Carrier			Weight
	<ul style="list-style-type: none"> • 4 plastic, load bearing wheels. • Ball bearing. • With side rope attachment. 			g
3140 6011	Colour: black			140

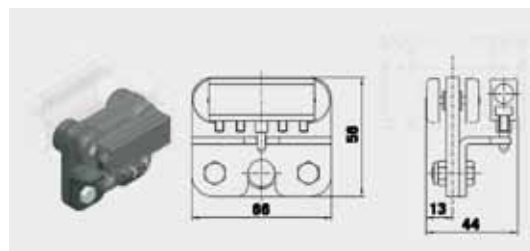

Art.- No.	Overlap Arm			Weight
	<ul style="list-style-type: none"> • Mounts to master runner. • With attachment screws. 			g
3140 0041	Colour: black			200
3140 0042	Colour: silver			200

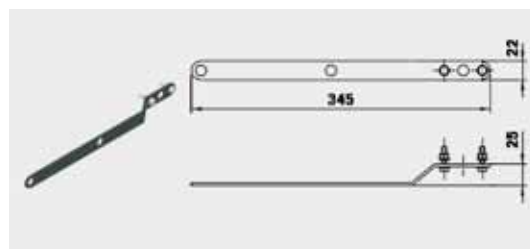

Art.- No.	Extension Arm			Weight
	<ul style="list-style-type: none"> • Mounts to runner. • Aligns one-piece curtain directly to the wall. • With attachment bolts. 			g
3140 0051	Colour: black			80
3140 0052	Colour: silver			80

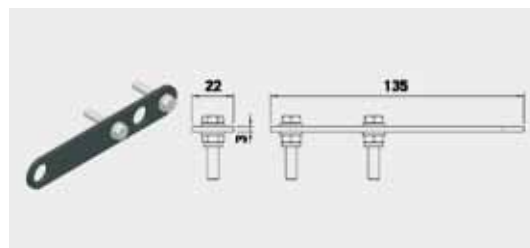

Art.- No.	End Stop			Weight
	<ul style="list-style-type: none"> • With curtain attachment. 			g
3140 1051	Colour: black			30
3140 1052	Colour: silver			30

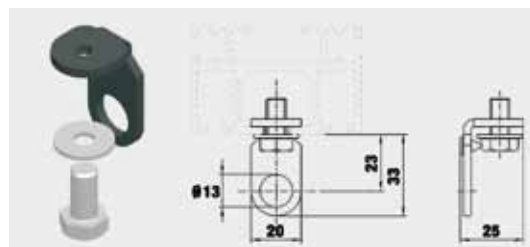

Art.- No.	Head Pulley			Weight
	<ul style="list-style-type: none"> • Diverts operating and returning rope to the floor. • Ball bearing. • With attachment kit. • For Ø 8 mm rope. 			g
3140 6021	Colour: black			749
3140 6022	Colour: silver			749

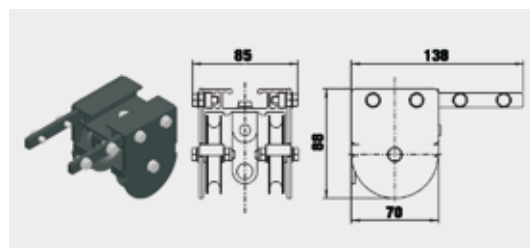

Art.- No.	Side by Side Head Pulley			Weight
	<ul style="list-style-type: none"> • Diverts operating and returning rope to the side. • Ball bearing. • With attachment kit. • For Ø 8 mm rope. 			g
3140 6031	Colour: black			981
3140 6032	Colour: silver			981

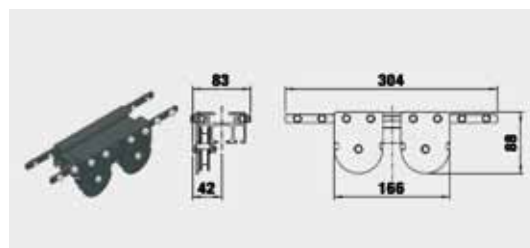

ELEGANCE
+ 3-WAY

1.40 3-WAY: Rope Drawn Operation

Art.- No.	Return Pulley			Weight g
	<ul style="list-style-type: none"> • Diverts rope at the end of track. • Ball bearing. • With attachment kit. • For Ø 8 mm rope. 			
3140 6041	Colour: black			369
3140 6042	Colour: silver			369

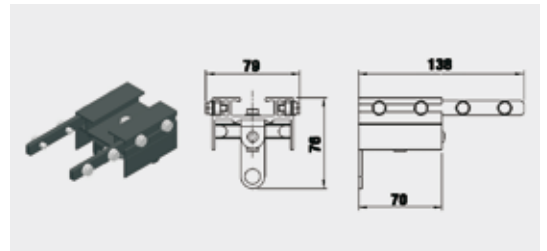

Art.- No.	Hook Clamp			Weight g
	<ul style="list-style-type: none"> • With attachment for direct track mounting. • For pipe diameter: 48 – 60 mm. 			
3140 8021	Colour: black			420
3140 8022	Colour: silver			420

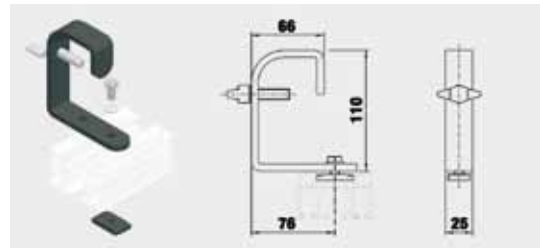

Art.- No.	Ceiling Mounting Bracket 10 Piece Set			Weight g/piece
	<ul style="list-style-type: none"> • For ceiling mounting. 			
3140 8031	Colour: black			70

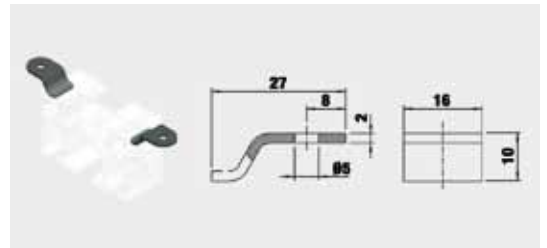

Art.- No.	Wall Mount Bracket 150		Length mm	Weight g
	<ul style="list-style-type: none"> • With attachment kit for direct track mounting. 			
3140 8061	Colour: black		150	486
3140 8062	Colour: silver		150	486

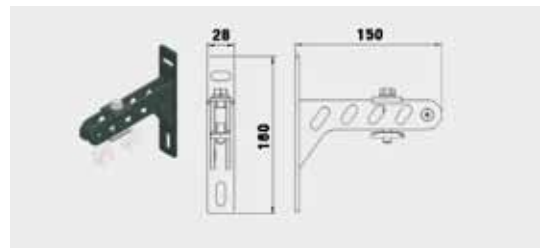

Art.- No.	Wall Mount Bracket 250		Length mm	Weight g
	<ul style="list-style-type: none"> • With attachment kit for direct track mounting. 			
3140 8071	Colour: black		250	654
3140 8072	Colour: silver		250	654

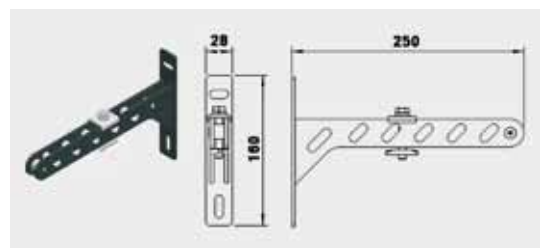

Art.- No.	Attachment Bolt M8			Weight g
	<ul style="list-style-type: none"> • For track mounting directly to pipe or battens. • With 3 nuts, washers and camlock nut. 			
3140 8052	Colour: silver			50

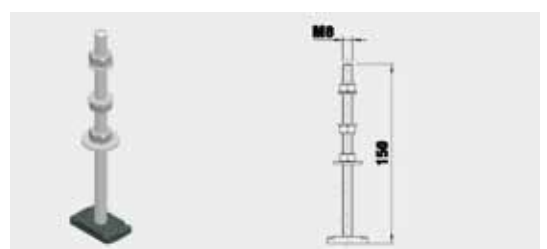

ELEGANCE
+ 3-WAY

1.40 3-WAY: Rope Drawn Operation

Art.- No.	Camlock Nut			Weight g
	<ul style="list-style-type: none"> • Can be positioned at any place in the top groove of the track. • With thread to accept M8 bolt. 			
3140 8012	Colour: silver			25

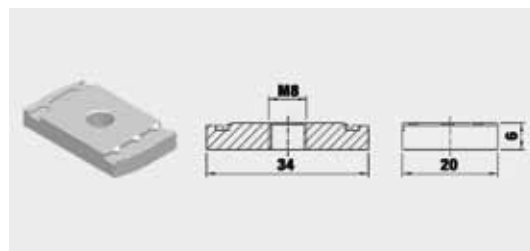

Art.- No.	Polyester Rope			Weight g/rm
	<ul style="list-style-type: none"> • Ø 8 mm. • Tensile strength: approx. 1.163 daN. • Maximum length: 200 m. • Non-stretch (approx. 4%). 			
4104 1182	Colour: black			40



Art.- No.	Floor Pulley			Weight g
	<ul style="list-style-type: none"> • With counterweight. • For Ø 8 mm rope. 			
3140 7011	Colour: black			1.310

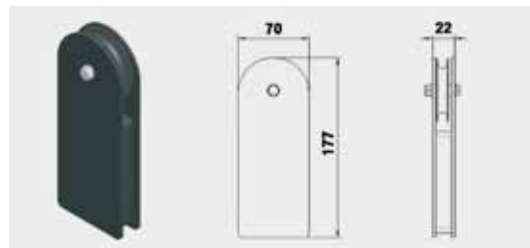

Gerriets GmbH
 Im Kirchenhürstle 5-7
 D-79224 Umkirch
 ☎ +49 7665 960-0
 ☎ +49 7665 960-125
 info@gerriets.com

Gerriets S. A. R. L.
 Rue du Pourquoi Pas
 F-68600 Volgelsheim
 ☎ +33 3 89 22 70 22
 ☎ +33 3 89 22 70 50
 gerriets@gerriets.com

Gerriets International Inc.
 130 Winterwood Avenue
 Ewing NJ 08638, USA
 ☎ +1 609 758-9121
 ☎ +1 609 758-9596
 mail@gi-info.com

Gerriets Great Britain Ltd.
 18 Verney Road
 London SE16 3DH, UK
 ☎ +44 20 7639 7704
 ☎ +44 20 7732 5760
 general@gerriets.co.uk

Gerriets Handel GmbH
 Gorskistraße 8
 A-1230 Wien
 ☎ +43 1 6000 600-0
 ☎ +43 1 6032 585
 verkauf@gerriets.at

Gerriets España S. L.
 Pol. Ind. Arroyo Buzanca
 Avda. de Las Moreras
 Sector S-19 B, Naves 1-2-3
 E-28350 Ciempozuelos, Madrid
 ☎ +34 91 134 5022
 ☎ +34 91 134 5084
 gerriets.spain@gmail.com

Gerriets Italia
 Risam for show
 Viale Spagna 150 / B
 I-20093 Cologno Monzese (MI)
 ☎ +39 02 2532 113
 ☎ +39 02 2532 130
 info@risamforshow.com

Gerriets Belgique
 Distribué par :
 Gerriets S. A. R. L.
 Rue du Pourquoi Pas
 F-68600 Volgelsheim
 ☎ +33 3 89 22 70 22
 ☎ +33 3 89 22 70 50
 gerriets@gerriets.com

Gerriets Nederland
 Anthony Fokkerweg 3
 NL-1059 CM Amsterdam
 ☎ +31 20-40 82 553
 ☎ +31 20-40 82 662
 info@gerriets.nl

Gerriets Greece
 info@gerriets.gr
 www.gerriets.gr

Gerriets Turkey
 Benart Ses Isik-ASC Is Merkezi
 Mahmut Sevket Pasa Mahallesi
 Piyale Pasa Bulvarı
 Baran Sk No: 4 Kat: 3 Zemin Kat
 TR-34384 Okmeydani-Sisli-Istanbul
 ☎ +90 212 254 33 43
 ☎ +90 212 254 33 53
 benart@benart.net

Gerriets Korea
 4F 449-4 Seongnae-dong
 Gangdong-gu, Seoul
 Korea 134-030
 ☎ +82 2 477 7713
 ☎ +82 2 477 1490
 info@gerriets.co.kr

www.gerriets.com

